

Varenummer: 203060M1280A2S
 Beskrivelse: E+G Justerfod
 GN 30-60-M12-80-A2-S
 Note: S Uden møtrik, udvendig sekskant i bunden

Mål

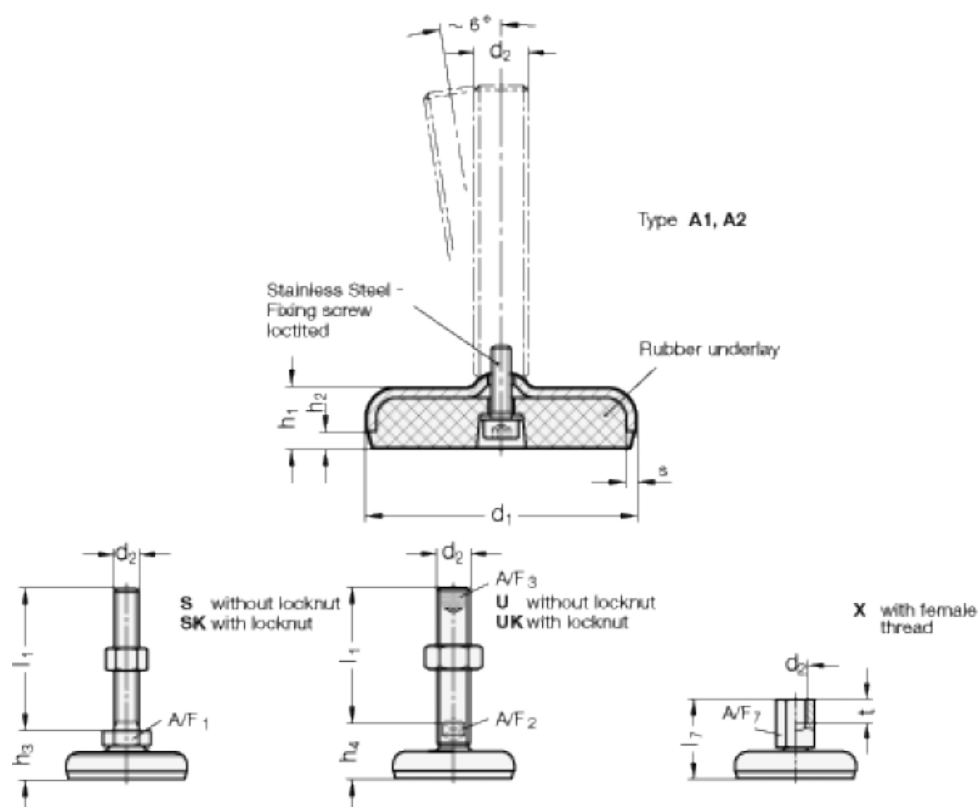

A/F1 = 17
 d_1 = 60
 d_2 = M12
 h_1 = 16
 h_2 = 4
 h_3 = 24
 l_1 = 80
 s = 3